

# ASSEMBLY INSTRUCTIONS

## CHAIR

Approximate Assembly Time



People Required to Assemble



No Extra  
Tools Required

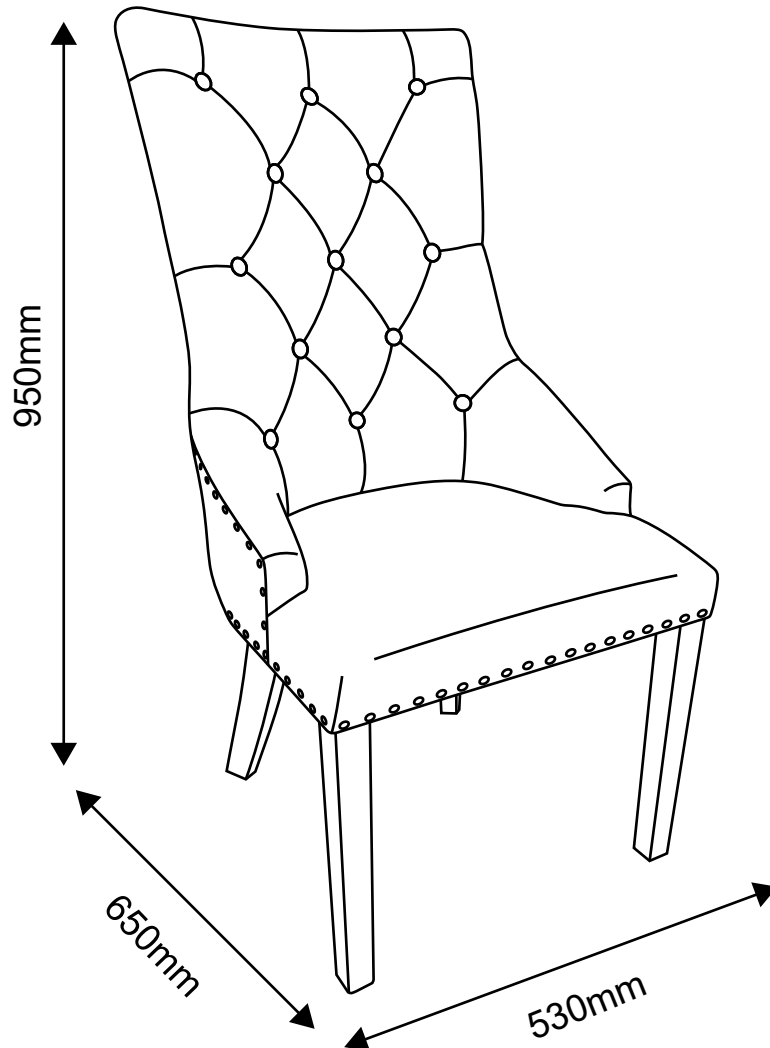

Before you start...

Please carefully unpack and lay out all of the component parts to ensure nothing is missing and to check each component for any obvious damage.

Should you identify any concerns at this stage please contact the retailer from whom this product was purchased. Please quote your order number, details of your issue, the product code, and the batch number from the cartons which will help to resolve your issue as quickly as possible.

**Version Number - 1.0**

**Product Code - GLA001**

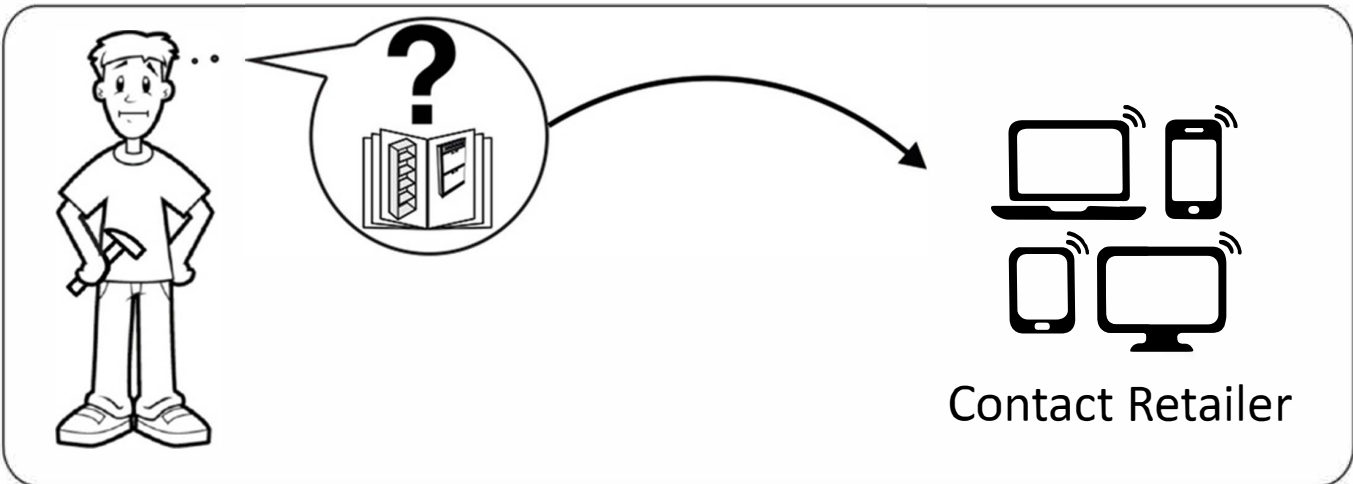
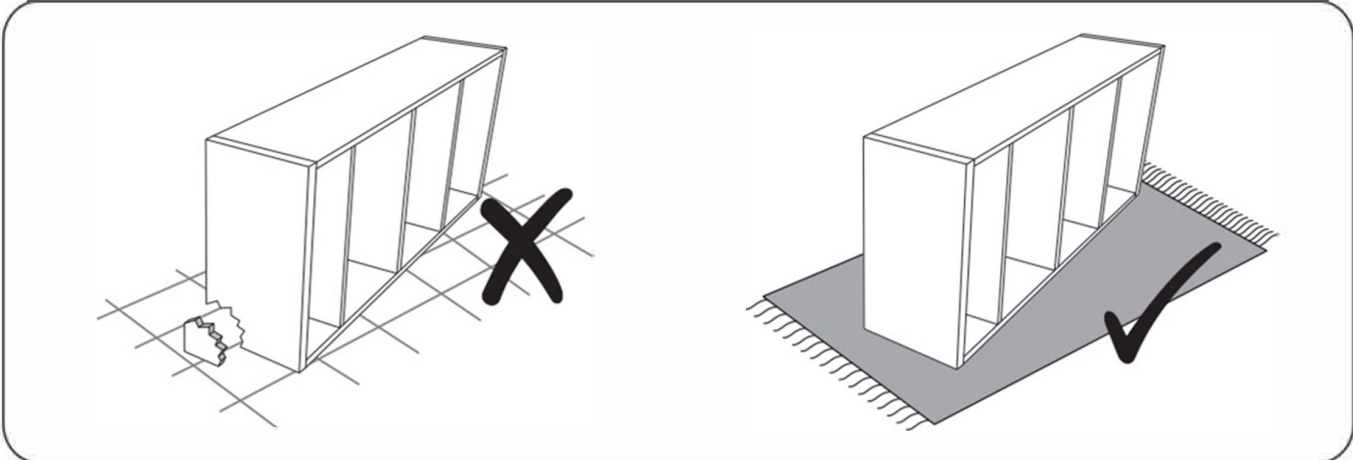
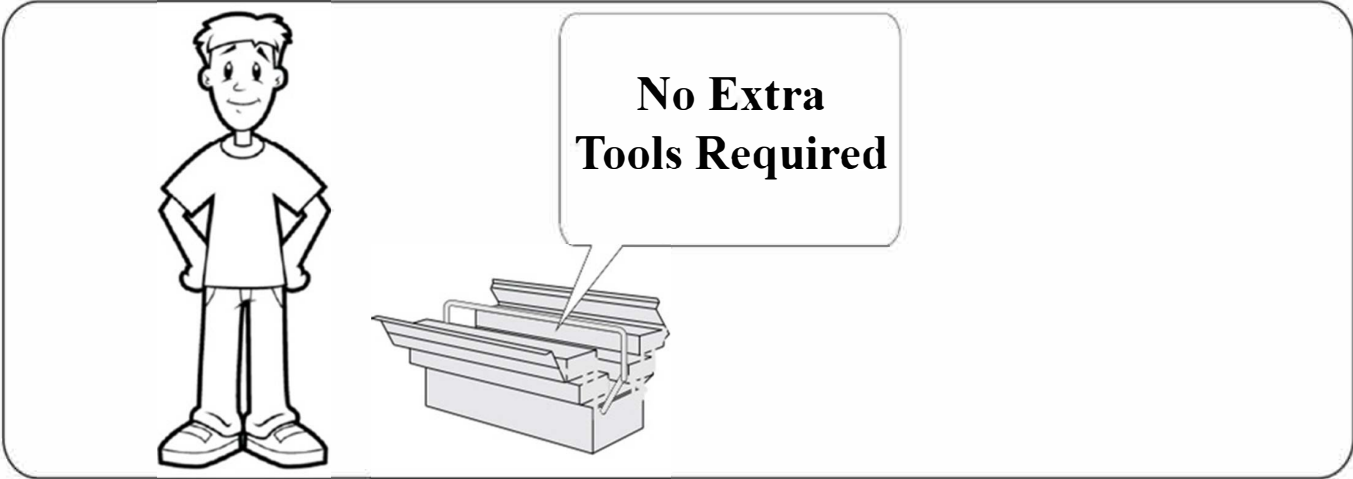

# HARDWARE

Please check all hardware matches the list below. Should you notice any are missing please contact your retailer.

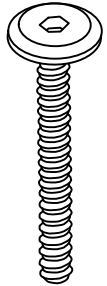

A

M8 x 55 MM = 8

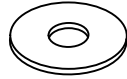

B

FLAT WASHER  
M8 x 22 MM = 8



C

ALLEN KEY M8 = 1

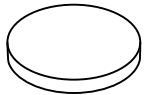

D

25MM x 25MM = 4

We strongly advise that you do not use Power Tools, such as drills or electric screwdrivers during the assembly as this may cause irreparable damage and will invalidate your warranty.

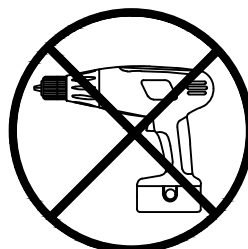

# PARTS

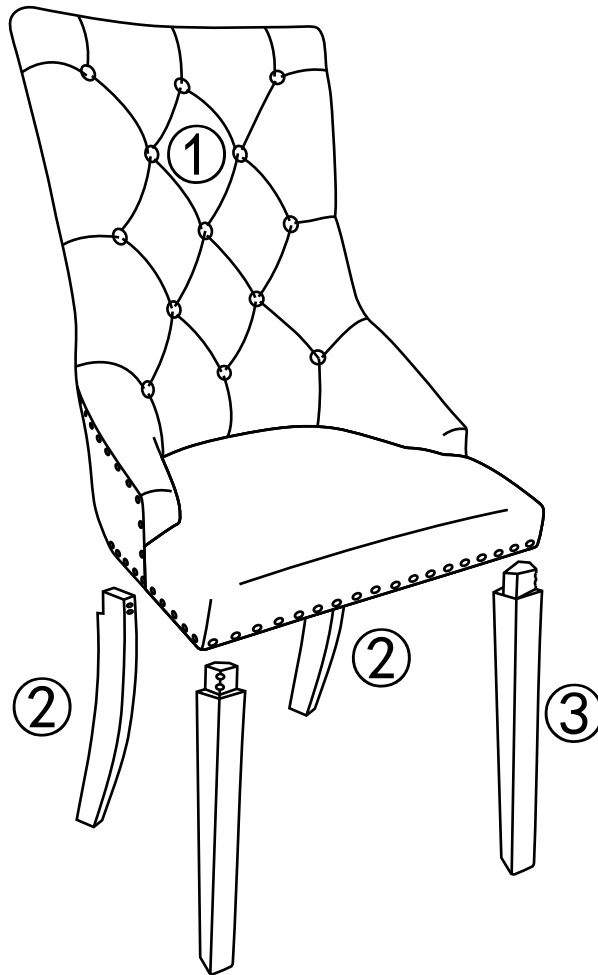

Please ensure you carefully check all the pieces, should you have any concerns please contact the retailer before assembly commences. Please have your order number, details of the issue, the product code, and the batch number from the cartons as this will help us to resolve your issue much faster.

## **ASSEMBLY ADVICE**

Please take the time to carefully read through these instructions before you commence.

Keep these instructions for future reference.

We advise that the product is assembled in the room it is intended for.

We advise that you keep the hardware in a bowl during assembly to avoid losing anything.

We strongly recommend that you keep children away from the work area.

Small component parts could choke a child if swallowed.

We recommend you use a sheet or blanket to protect both floor and product through the assembly stages.

This product is heavy, and we recommend a 2 person lift to avoid personal injury or damage to the product.

Never push or pull the product as this could cause both personal injury or irreparable damage to product or floor.

We have tried to make this piece of furniture easy to assemble if the instructions are followed carefully.

In the unlikely event that you have problems with assembling the product or have missing or damaged parts, please contact your retailer and we will assist them in rectifying the problem as quickly as possible.

Please remember we strongly urge you **DO NOT** use power tools such as drill or electric screwdrivers as this could cause irreparable damage to your product and will invalidate your warranty.

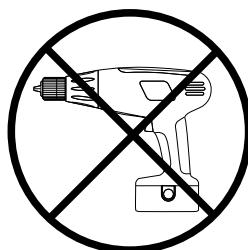

# 1

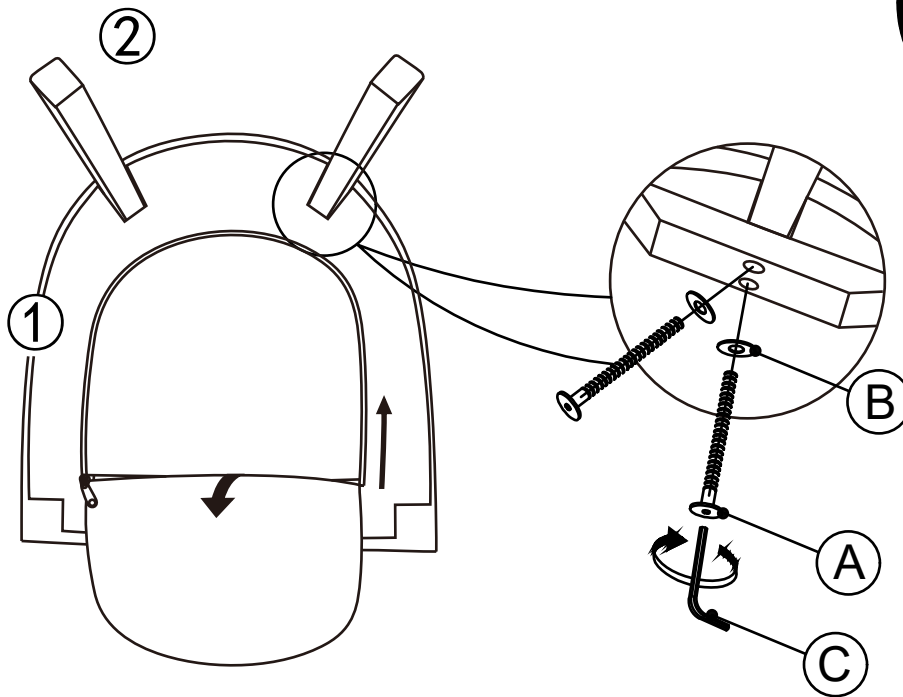

**Please do not fully tighten any bolts until the final step.**

# 2

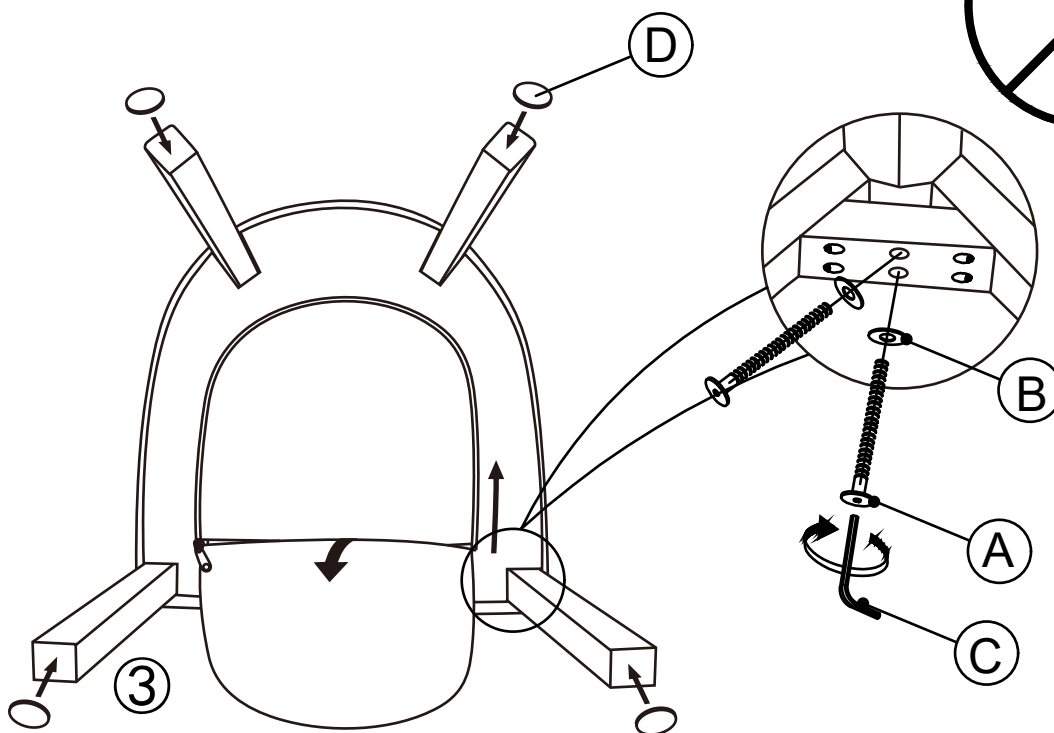

# 3

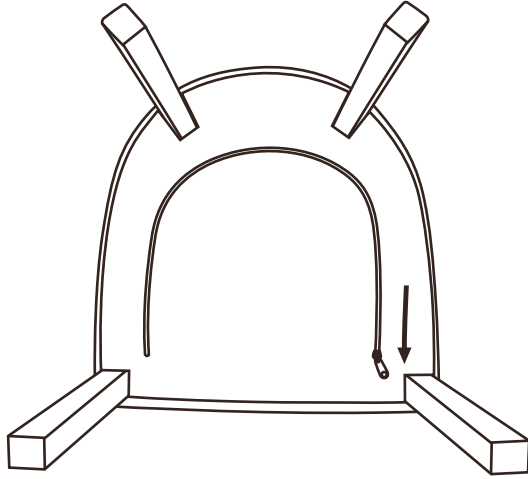

**IMPORTANT** Carefully turn the chair upright and place on a flat surface. Make adjustments to ensure that the chair frame is straight and that the legs are even on the floor then **FULLY TIGHTEN ALL BOLTS** assembled in previous steps using Allen key(C).

# 4

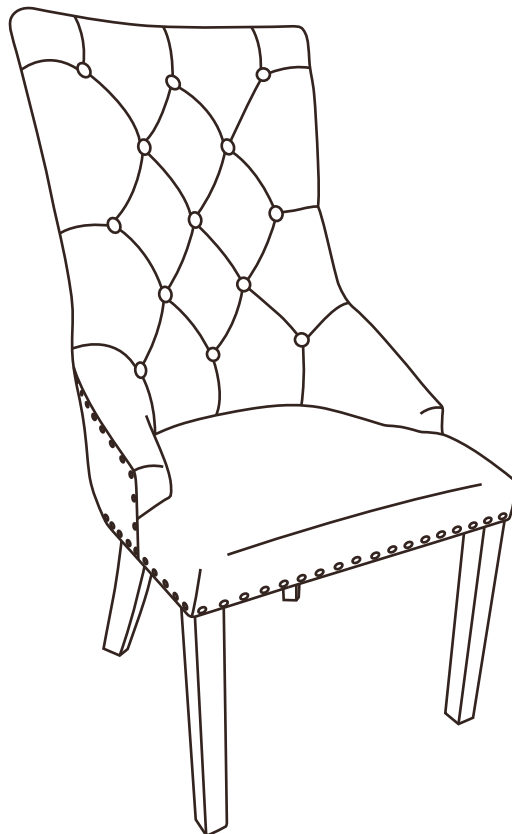

# 5

## **General Care**

**Wipe clean with a slightly damp soft cloth.**

**Avoid the use of all household cleaners and abrasives.**

**When moving your furniture, carefully lift into place.**

**Never drag or push the pieces across the floor as this will cause damage to the joints and could result in failure to the product that will invalidate the warranty.**

## **Recommendations**

**Periodical re-tightening of fixings.**

## **Notes**

**We've tried to make this piece of furniture as easy to assemble as possible.**

**In the unlikely event that you have problems putting it together or have damaged or missing pieces, please contact your retailer.**